

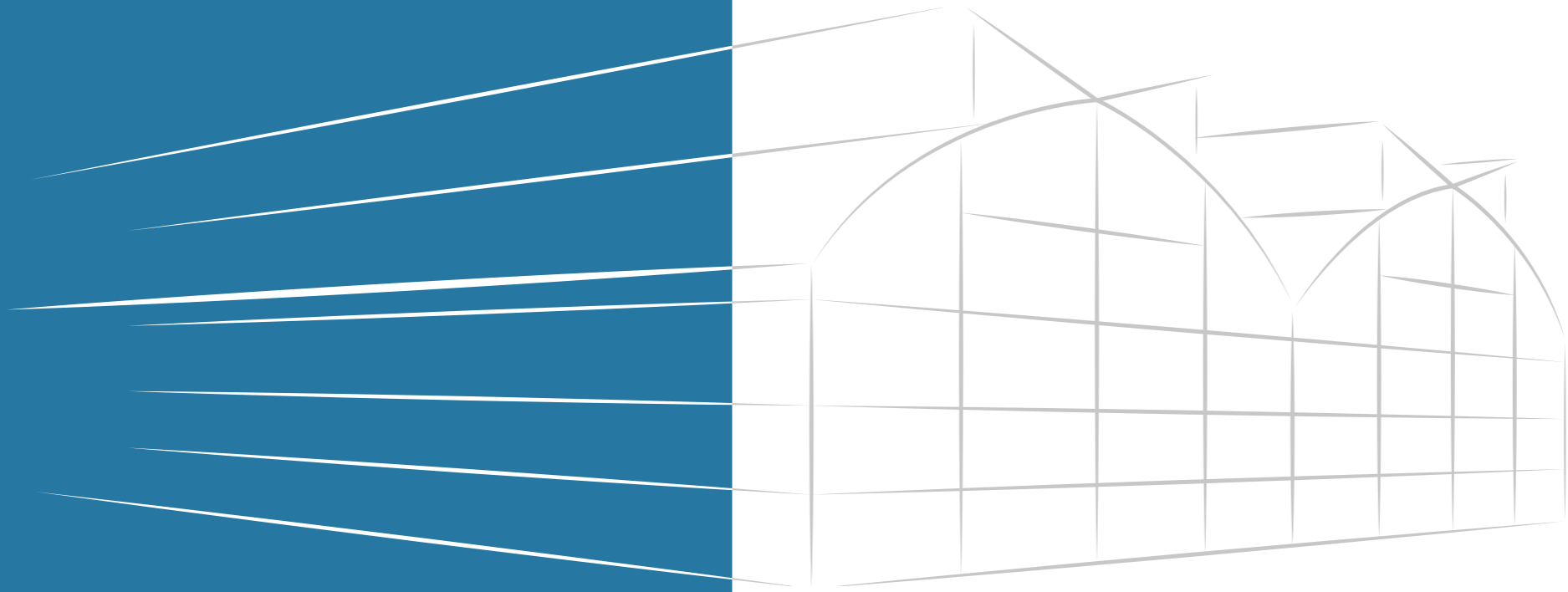

Modern Seracılıkta Profesyonel Çözümler



Modern Seracılıkta Profesyonel Çözümler







## Konstrüksiyon Sistemleri

### Multi Tünel Sera Konstrüksiyonları

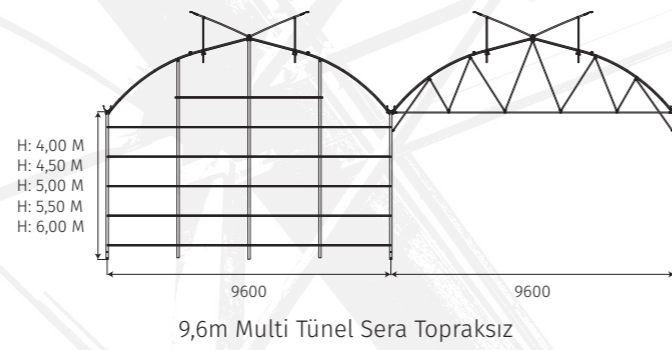
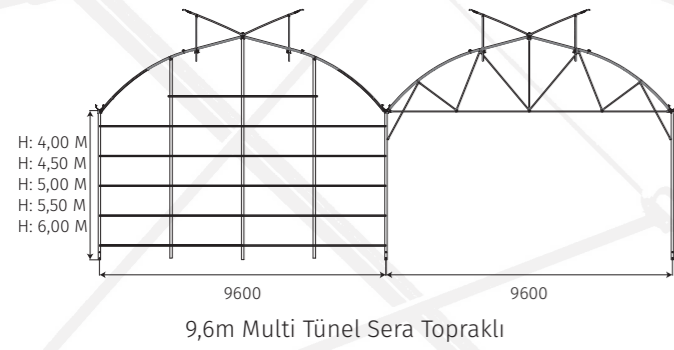
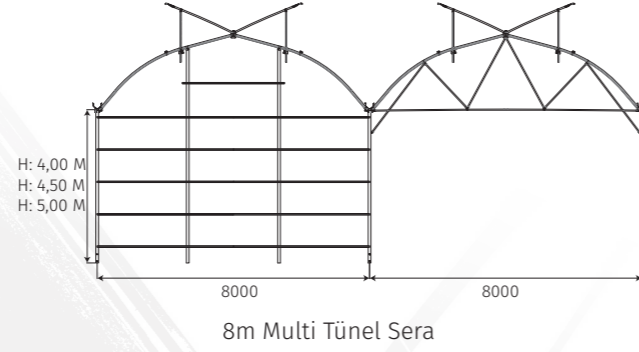
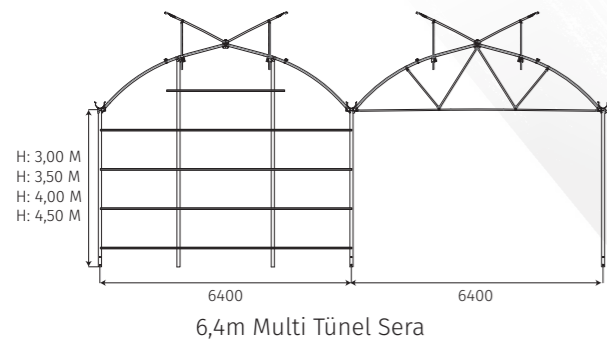

### Tünel Sera Konstrüksiyonları

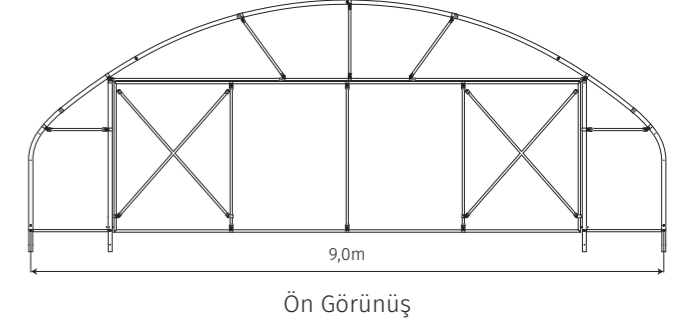
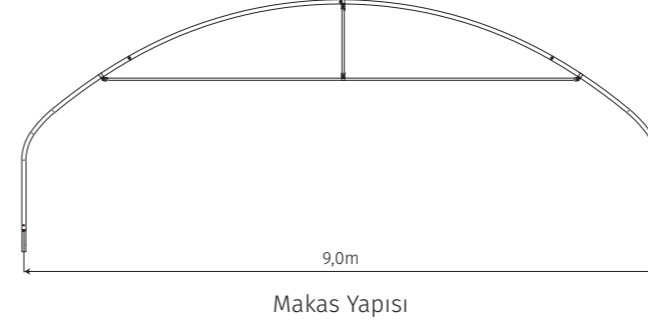

9m Tünel Sera Modeli

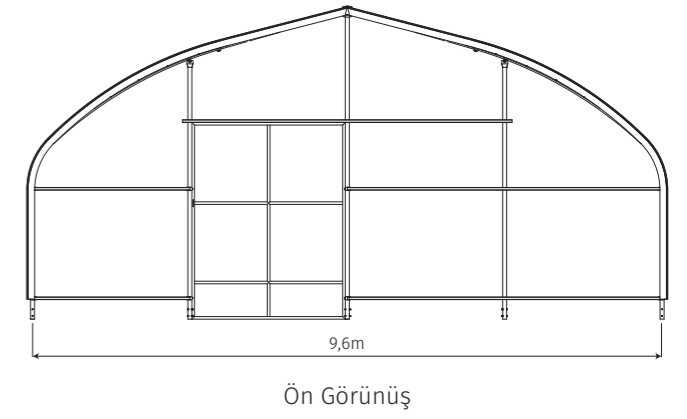
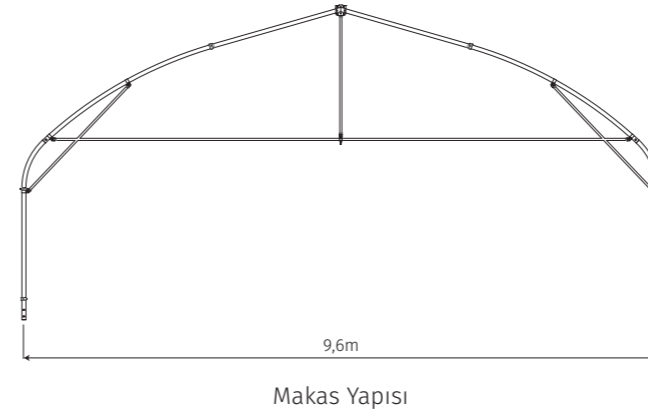

9,6m Tünel Sera Modeli

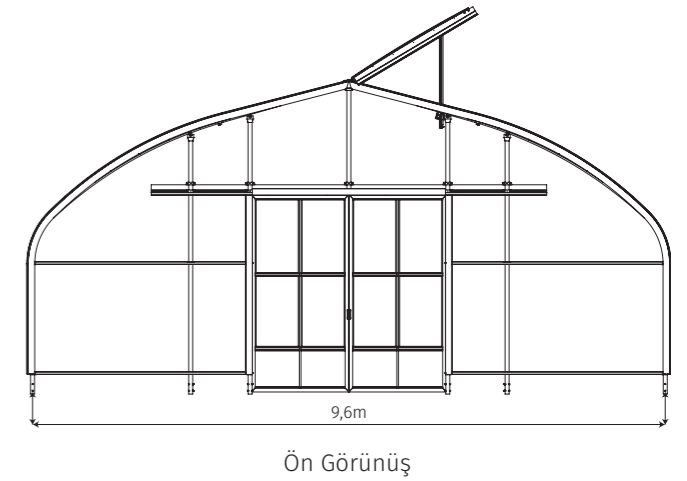
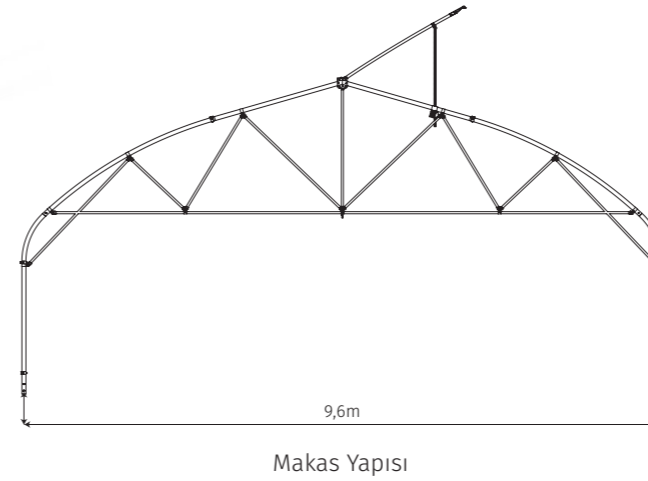

9,6m Tünel Sera Modeli



**Bitki Askı Tel Sistemleri**

Kod	Ürün	3 mm	4 mm	8 mm	10 mm
1100-27	Galvanizli Çelik Halat		✓	✓	✓
1100-17	Galvanizli Tel	✓	✓		



**Polikarbon**

Kod	Kalınlık	Ölçü	Odacık Sayısı	Duvar Sayısı
1500-01	8 mm 10 mm	2,1 mm	1	2
			2	3
			3	4

- Montaj kolaylığı
- Homojen ışık dağılımı
- Mükemmel ısı ve ses yalıtımı
- Çift ya da tek taraflı UV koruması

- Farklı iklim koşullarına (-40°C, +120°C) dayanıklılık
- Darbe dayanıklılığı
- Kimyasallara karşı yüksek direnç
- Zararlı ışık engelleyici

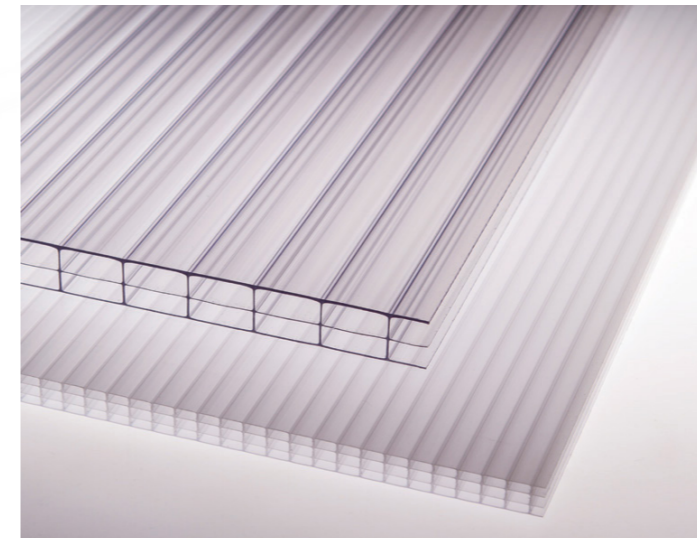

1500-06 Polikarbon H bağlantı Profili AYS

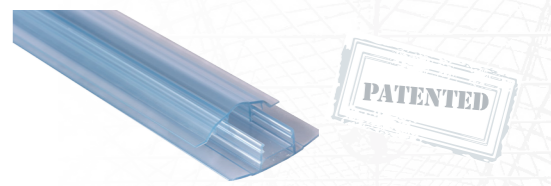

1500-02 Standart Polikarbon H bağlantı Profili





Plastik Örtü

Kod	Ürün	Katkı Ömrü	Kalınlık	Katkı Özellikleri
1700-01	Plastik Sera Örtüleri	12 Ay	150 Micron	Uv
		18 Ay	180 Micron	Light Diffuser
		24 Ay	180 Micron	Ir
		36 Ay	200 Micron	Eva
		60 Ay	200 Micron	Anti Fog (Anti Drip)
				Anti Mist
				Anti Dust
				Av
				Cooling
				Sulphur Resistant



Sinek Tülü

Kod	Ürün	Mesh
1600-02	Sinek Tülü	40
		50

- Minimum 1,5 mm genişlik
- Maksimum 2m tek parça genişlik veya dikilebilirliği sayesinde daha büyük genişlikler elde edebilme
- Maksimum 400 m uzunluk.

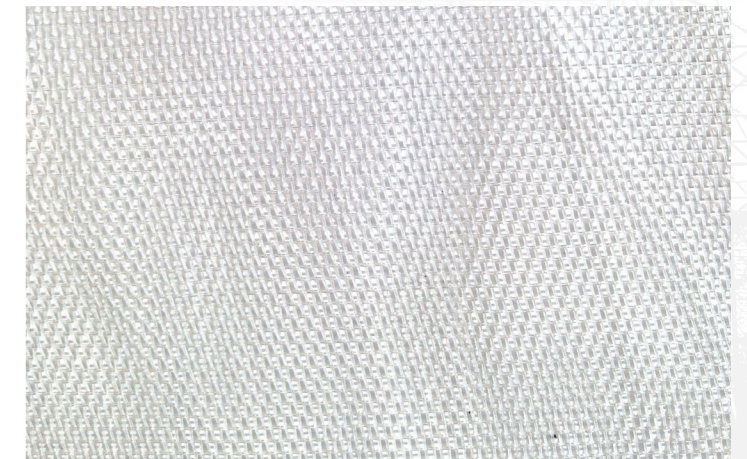



## Yer Örtüsü

Kod	Renk Opsiyonu	Beyaz - Beyaz	Beyaz - Siyah
1800-01	Genişlik	335cm/415cm/525cm	200cm/325cm/525cm
	Kesilebilirlik	✓	✓
	Menşei	İthal / Yerli	İthal / Yerli



## Isı Perdesi ve Mekanizması

Kod	Isı Perdesi	pH 55	pH 66	pH 77
1200-20	Genişlik	325cm/430cm/480cm/530cm	325cm/430cm/480cm/530cm	325cm/430cm/480cm
	Işık Geçirgenliği	%45	%35	%25
	Gölgeleme	%55	%65	%75

- Mekanizma 8m ve 9,6m'lik tünel ölçülerine göre yapılabilir.
- Push-pull mesafesi 2,5m, 3m veya 5m olarak ayarlanabilir.

### Push-Pull Sisteminde Perde Mekanizma Opsiyonları

- Alüminyum profilli push-pull
- Ø21 borulu push-pull

\* Mekanizma sistem olarak satılmaktadır. Perde ayrı veya sistem dahilinde alınabilir.

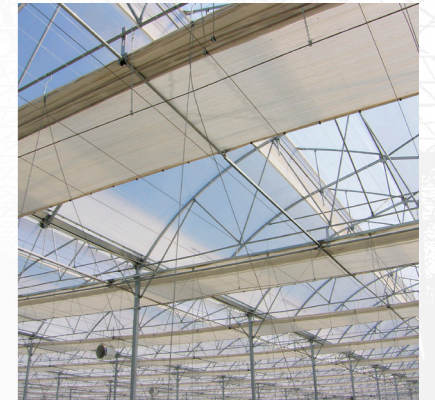
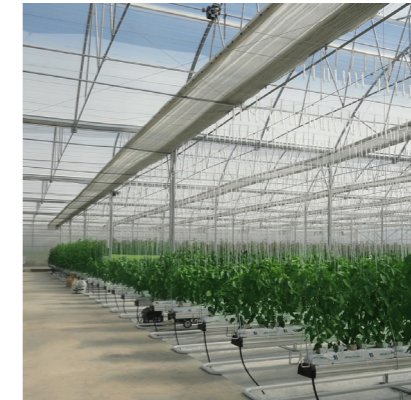



Fanlar



Gutter ve Bağlantı Aparatları



**Sirkülasyon Fanları**

Ürün Kodu	Gerilim Volt	Frekans Hz	Güç Watt	Debi m <sup>3</sup> /h	Devir min-1TIP - YTPE
1009-16	220/380	50	160	4100	1400
1009-17	220/380	50	160	5890	1400
1009-18	220/380	50	250	7400	1400
1009-19	220/380	50	400	8900	1400

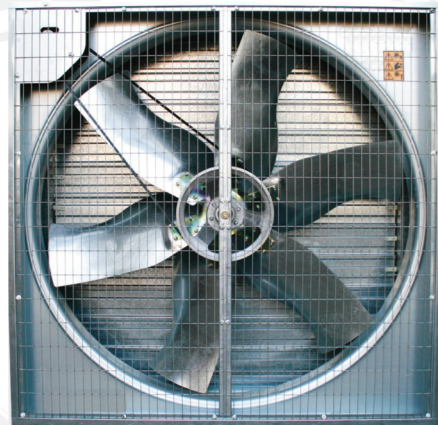

**Egzoz Fanları**

Ürün Kodu	Gerilim Volt	Frekans Hz	Güç Watt	Debi m <sup>3</sup> /h	Devir min-1TIP - YTPE
1009-23	380	50	370	10500	1400
1009-22	380	50	1100	40500	1400

**1300-19 Gutter Sistemi**

- 0,6 mm kalınlıkta 60 cm sac açılımı epoksi boyalı gutter
- Galvanizli askı aparatları
- Bitki taşıma telleri
- Yük taşıma telleri
- Gutter ucu bitki yatırma telleri
- Gutter bitki ısıtma borusu taşıma kancası
- Plastik drenaj kapağı
- Plastik gutter kapağı

Sistem olarak satın alınabilmektedir

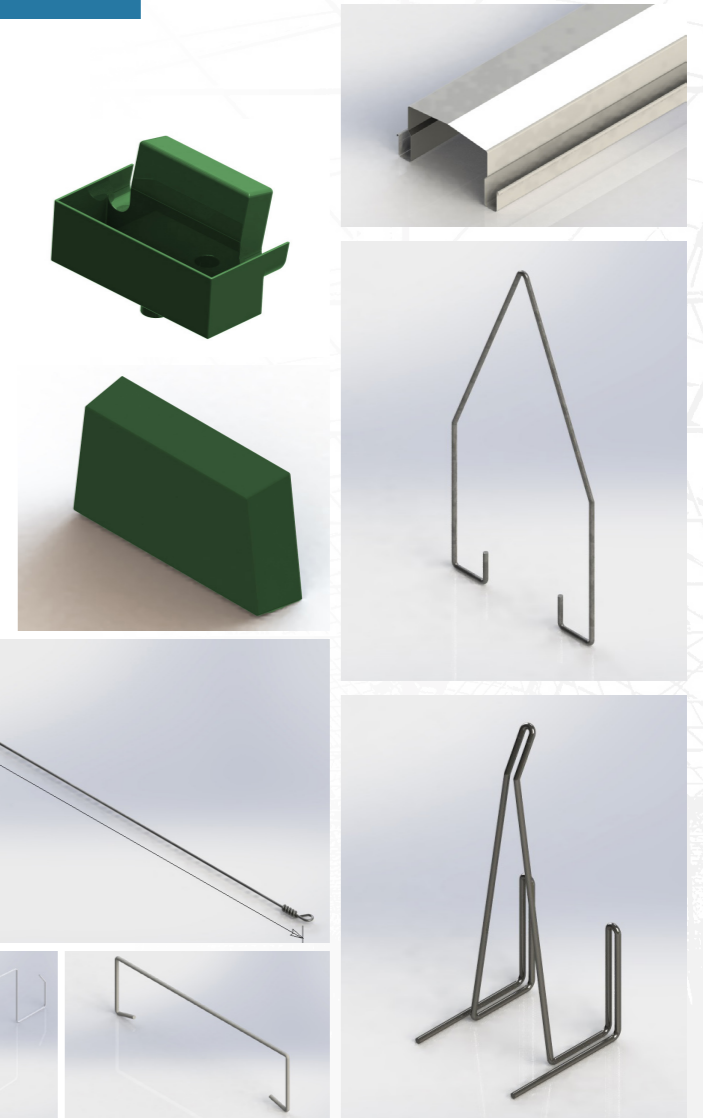





Isıtma Kazanları



Isıtma Boruları, Spot Ayaklar



2800-46DG  
DOĞAL GAZ KAZANI



2800-46JE  
JEOTERMAL EŞANJÖR SİSTEMLERİ



2800-46KY  
KÖMÜR KAZANLARI

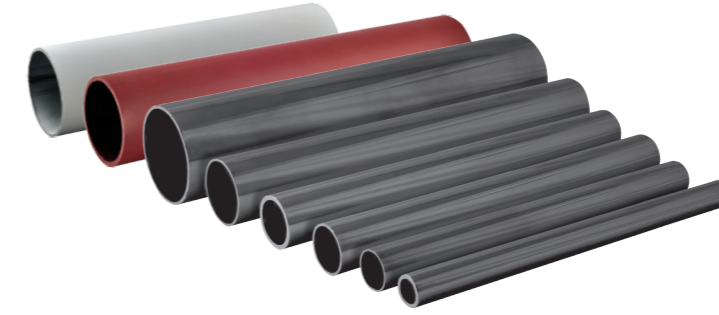

Isıtma Boruları			
Kod	Çap	Et Kalınlığı	Uzunluk
2800-16	48 mm		
2800-08	51 mm	2 mm	
2800-06	76 mm	2,5 mm	
2800-05	89 mm	3 mm	6-9 m
2800-11	114 mm	4 mm	
2800-02	140 mm	4,5 mm	
2800-15	273 mm		



2800-01  
SPOT AYAKLAR



**Kokopit**

1300-25 KOKOPİT

- Slabların değişik boyutları bulunmaktadır.
- Talebe uygun hacimlerde temin edilebilir.
- Tüm slablar; UV katkıli plastik ile kaplıdır.
- Talebe uygun karışım oranlarında temin edilebilir.



**Hasat ve İşlem Arabaları**



9907-04 TROLLEY HASAT ÇEKME ARABALARI

Hasat toplama, ilaçlama, kültürel işlem arabaları ve troli hasat çekme arabaları montajlı ve kullanıma hazır vaziyette üretilir.



İLAÇLAMA ARABALARI



9907-03 HASAT TOPLAMA ARABALARI (TEK KAT)  
9907-06 HASAT TOPLAMA ARABALARI (ÇİFT KAT)



9907-02A  
KÜLTÜR İŞLEM ARABASI



9907-02B  
KÜLTÜR İŞLEM ARABASI



Hijyen Turnikesi

2100-09 Hijyen Turnikesi



Sisleme Sistemi

9909-09 Yüksek Basınç Sisleme Sistemi  
9909-12 Alçak Basınç Sisleme Sistemi

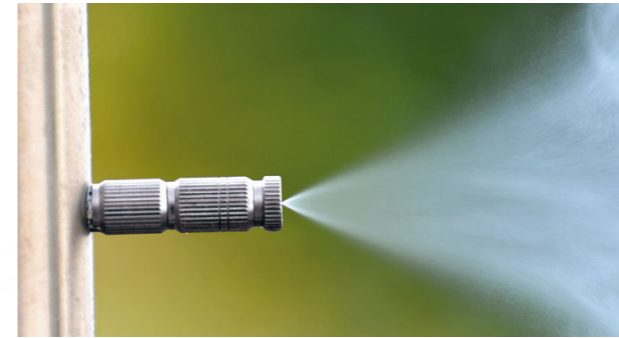



Modern Seracılıkta Profesyonel Çözümler



Çilek Mh. Tirmil Sanayi Bölgesi  
63140 Sk. Mersin / Türkiye

**Contact Phones**

**Fabrika/Factory** : +90 324 234 02 07

**Türkçe** : +90 541 611 50 82

**English&Français** : +90 530 386 49 88

**По-русский** : +90 530 668 91 60

**العربية** : +90 533 695 99 06

[info@aysproje.com](mailto:info@aysproje.com)

[www.aysproje.com](http://www.aysproje.com)

[www.aytekin.com.tr](http://www.aytekin.com.tr)

